

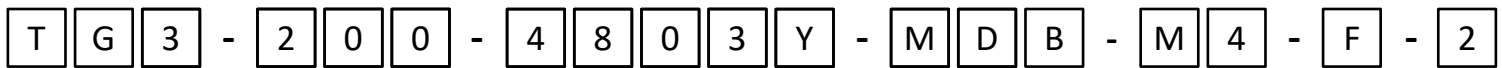

SPD with Thermally Protected MOVs for Switchboards & Panelboards

Product Number Configuration Guide

Product Number Example:



Application Specific Model Number:

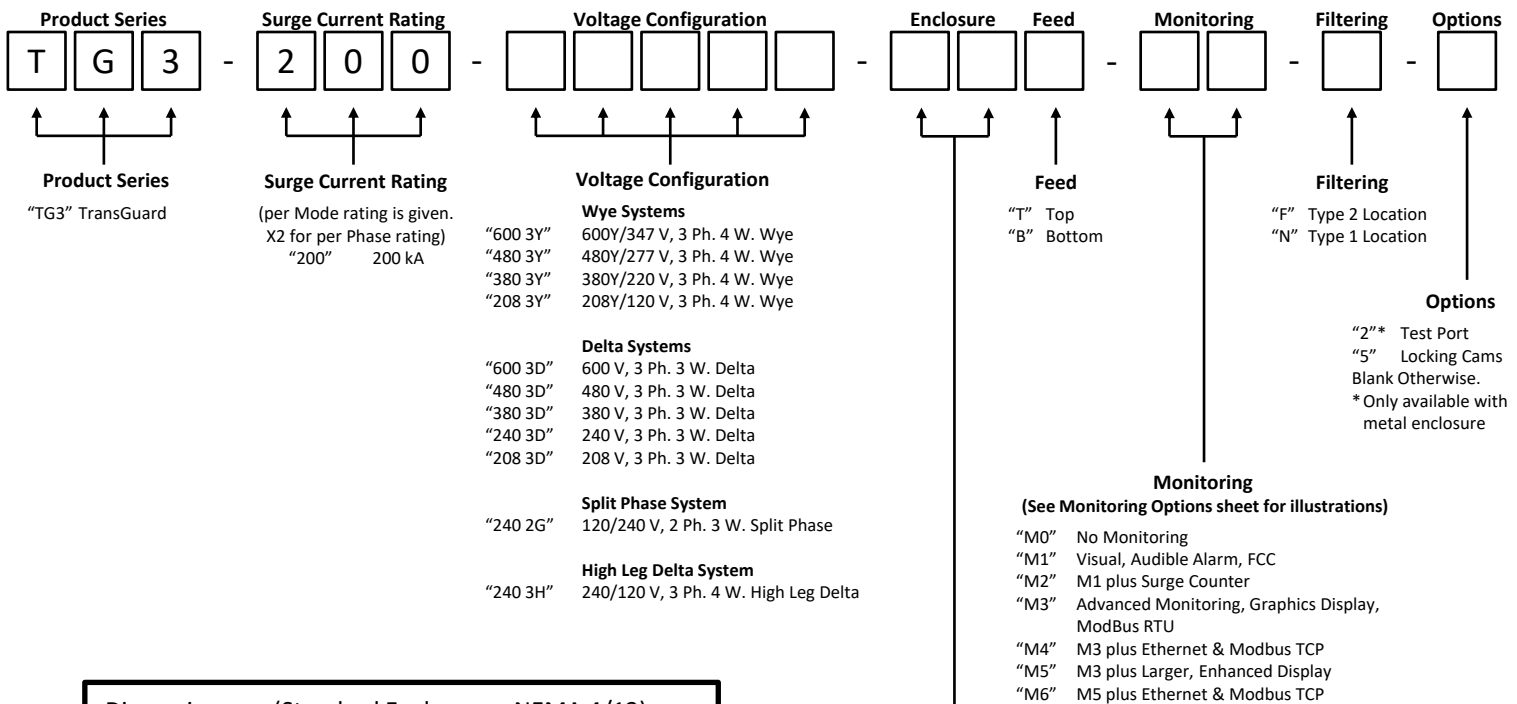

Dimensions	(Standard Enclosures: NEMA 4/12)
	Metal Enclosure
TG3-200:	24"h x 16"w x 9.20"d 50 lbs.
	Plastic Enclosure
TG3-200:	16.75"h x 14.75"w x 6.7"d 24 lbs.